

Features

- Input voltage: 1.5V~8V
- Output range: 1.2V~5.0V
- Maximum output current: 400mA @ VOUT=3.3V
- PSRR: 60dB @1KHz
- Dropout voltage: 180mV @ IOUT=100mA
- Quiescent current: 0.5μA Typ.
- Shut-down current: <1μA
- Recommend capacitor: 1μF
- Built-in Short-Circuit Protection, Current Limiter

Applications

- Radio control systems
- Cellphones, radiophone, digital cameras
- Bluetooth, wireless handsets
- Others portable consumer equipments

General Description

The TX6214 is a high accuracy, low noise, high speed CMOS Linear regulator with low power consumption and low dropout voltage, which provide large output currents even when the difference of the input-output voltage is small. The devices offer a new level of cost effective performance in cellular phones, laptop and notebook computers, and other portable

devices.

The current limiter's fold-back circuit also operates as a short circuit protection and an output current limiter at the output pin.

The TX6214 regulators are available in standard SOT23-3, SOT23-5 and DFN1*1-4 packages. Standard products are Pb-free and Halogen-free.

Selection Table

Part No.	Package	Temperature	Tape & Reel
TX6214-XXMR	SOT23-3	-40 ~ +85°C	3000/REEL
TX6214-XXM5R	SOT23-5	-40 ~ +85°C	3000/REEL
TX6214-XXFCR	DFN1*1-4	-40 ~ +85°C	10000/REEL

Note: XX indicates 1.2V~5.0V by 0.1V step. For example, 28 means product outputs 2.8V

Order Information

TX6214-①②③④⑤

Designator	Symbol	Description
①②	Integer	Output Voltage(1.2~5.0V)
③④	M	Package:SOT23-3
	M5	Package:SOT23-5
	FC	Package: DFN1*1-4
⑤	R	RoHS / Pb Free
	G	Halogen Free

Block Diagram

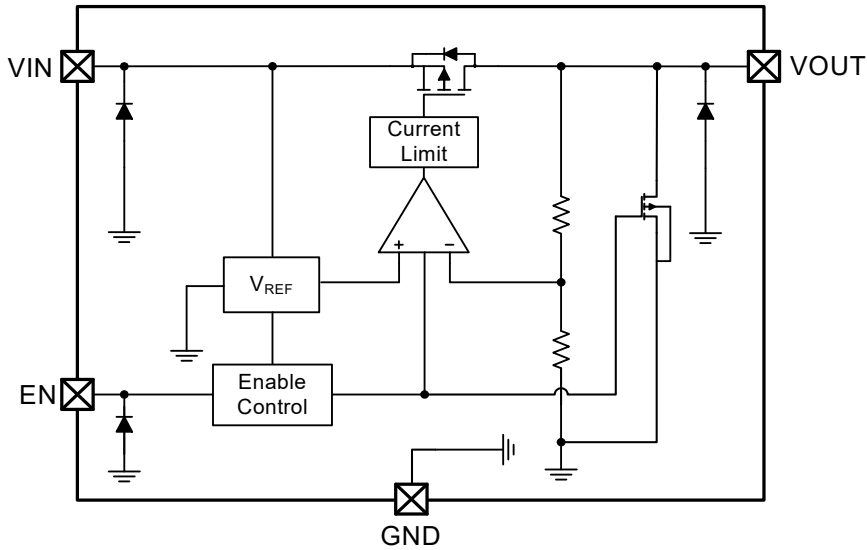

Pin Assignment

SOT23-3 (Top View)

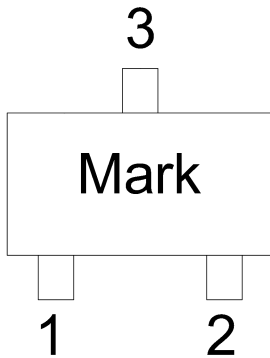

Table1: TX6214-XXMR series (SOT23-3 PKG)

PIN NO.	PIN NAME	FUNCTION
1	GND	GND pin
2	VOUT	Output voltage pin
3	VIN	Input voltage pin

SOT23-5 (Top View)

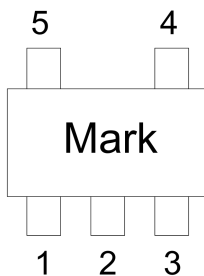

Table2: TX6214-XXM5R series (SOT23-5 PKG)

PIN NO	PIN NAME	FUNCTION
1	VIN	Input
2	GND	Ground
3	EN	Enable(Active high, not floating)
4	NC	Not connected
5	VOUT	Output

DFN1X1-4

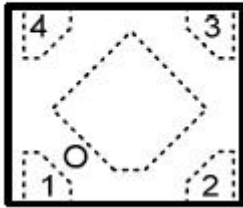

Table3

: TX6214-XXFCR series (DFN1*1-4PKG)

PIN NO	PIN NAME	FUNCTION
1	VOUT	Output
2	GND	Ground
3	EN	Enable(Active high, not floating)
4	VIN	Input

Absolute Maximum Ratings

Input Voltage.....	-0.3V to 9V	Storage Temperature	-55°C to 150°C
Output Current.....	450mA	Package Lead Soldering Temperature.....	260°C
Operating Temperature	-40°C to 85°C	Junction Temperature.....	-40°C to 125°C

Note: These are stress ratings only. Stresses exceeding the range specified under “Absolute Maximum Ratings” may cause substantial damage to the device. Functional operation of this device at other conditions beyond those listed in the specification is not implied and prolonged exposure to extreme conditions may affect device reliability.

Thermal Information

Symbol	Parameter	Package	Max.	Unit
θ_{JA}	Thermal Resistance (Junction to Ambient) (Assume no ambient airflow, no heat sink)	SOT23-3	500	°C/W
		SOT23-5	500	
		DFN1*1-4	500	
P_D	Power Dissipation	SOT23-3	0.40	W
		SOT23-5	0.40	
		DFN1*1-4	0.40	

Note: P_D is measured at $T_A = 25^\circ\text{C}$

Electrical Characteristics

The following specifications apply for $V_{OUT} = 3.3\text{V}$, $T_A = 25^\circ\text{C}$, unless specified otherwise

SYMBOL	ITEMS	CONDITIONS	MIN	TYP	MAX	UNIT
V_{IN}	Input Voltage		1.5	--	8	V
V_{OUT}	Output Range	$I_{OUT} = 1\text{mA}$	-2	V_{OUT}	2	%
I_Q	Quiescent Current	$V_{OUT} = 3.3\text{V}$, $I_{OUT} = 0$	--	0.5	--	μA
I_{LIMIT}	Current Limit	$V_{IN} = V_{EN} = 4.5\text{V}$	--	400	--	mA
V_{DROP}	Dropout Voltage	$V_{OUT} = 3.3\text{V}$, $I_{OUT} = 100\text{mA}$	--	180	--	mV
		$V_{OUT} = 3.3\text{V}$, $I_{OUT} = 200\text{mA}$	--	400	--	
ΔV_{LINE}	Line Regulation	$V_{IN} = 2.7 \sim 5.5\text{V}$, $I_{OUT} = 1\text{mA}$	--	0.01	0.15	%/V
ΔV_{LOAD}	Load Regulation	$V_{OUT} = 3.3\text{V}$, $I_{OUT} = 1 \sim 300\text{mA}$	--	200	--	mV
I_{SHORT}	Short Current	$V_{EN} = V_{IN}$, V_{OUT} Short to GND with 1Ω	--	35	--	mA
I_{SHDN}	Shut-down Current	$V_{EN} = 0\text{V}$	--	--	1	μA
PSRR	Power Supply Rejection Rate	$V_{IN} = 5V_{DC} + 0.5V_{P-P}$ $F = 1\text{KHz}$, $I_{OUT} = 10\text{mA}$		60		dB
V_{ENH}	EN logic high voltage	$V_{IN} = 5.5\text{V}$, $I_{OUT} = 1\text{mA}$	1.2	--	V_{IN}	V
V_{ENL}	EN logic low voltage	$V_{IN} = 5.5\text{V}$, $V_{OUT} = 0\text{V}$	--	--	0.4	V
I_{EN}	EN Input Current	$V_{EN} = 0$ to 5.5V	--	--	1	μA

Application Circuits

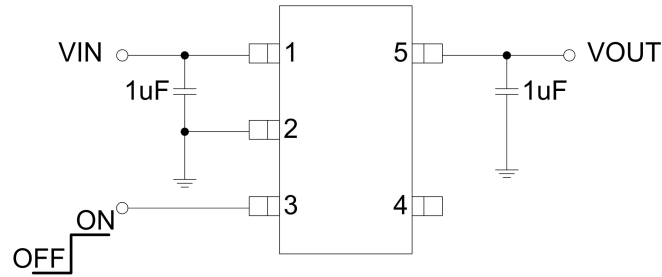

Typical Performance Characteristics

$C_{IN}=1\mu F$, $C_{OUT}=1\mu F$, $V_{IN}=4.5V$, $V_{OUT}=3.3V$, SOT23-5, $T_A=25^\circ C$

(Unless specified otherwise. Package: SOT23-5L)

(1) Quiescent current vs Input voltage

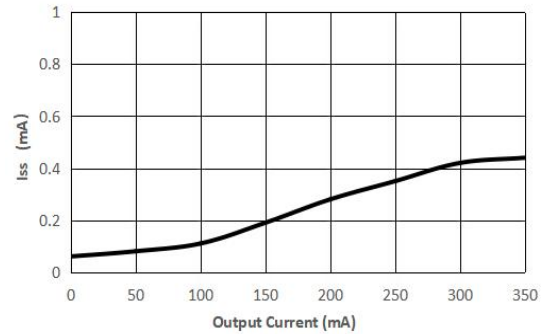
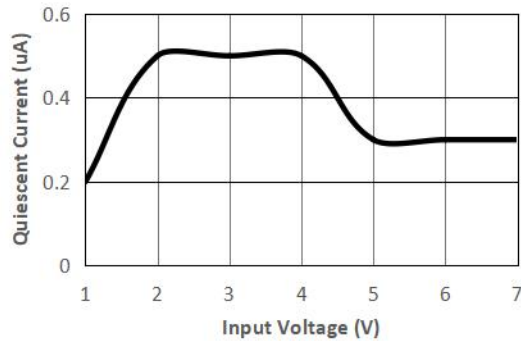

(2) Output Voltage vs Input voltage

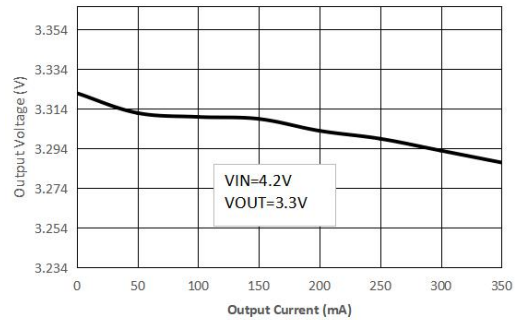
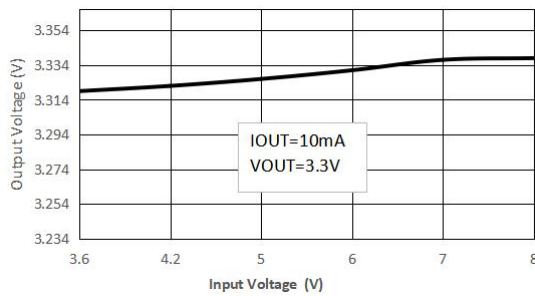

(3) PSRR vs Frequency

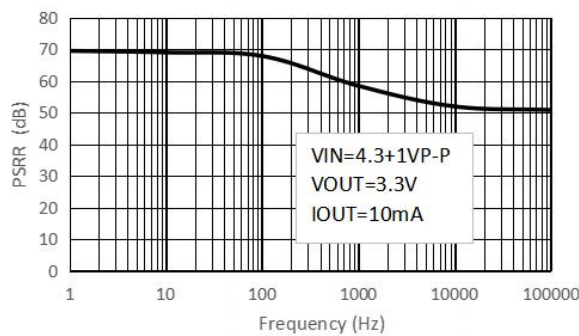

Power ON / OFF

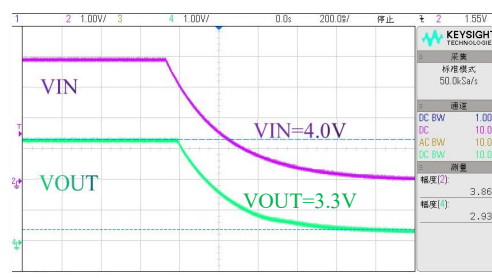
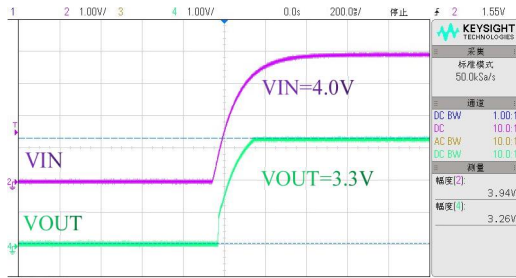

EN ON/OFF

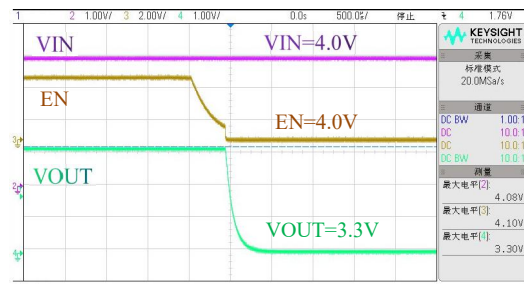
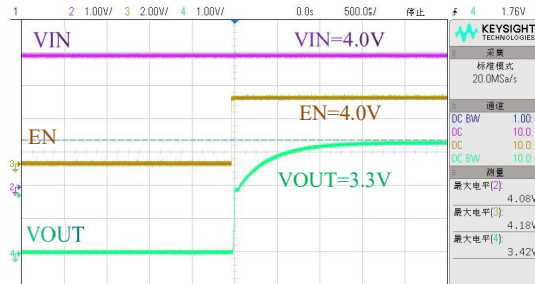

Line Transient

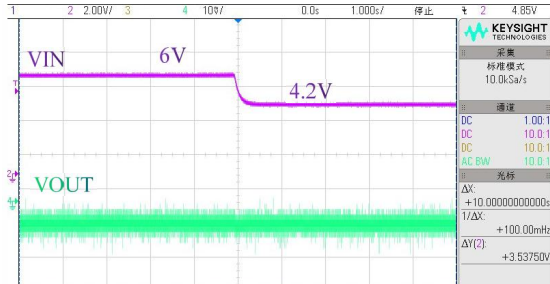
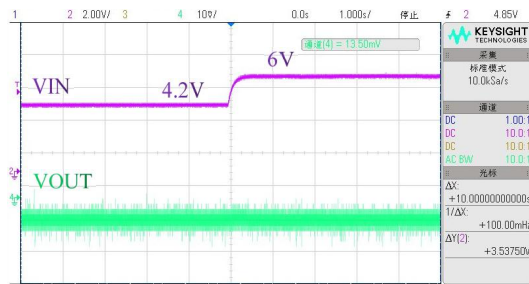

Load Transient

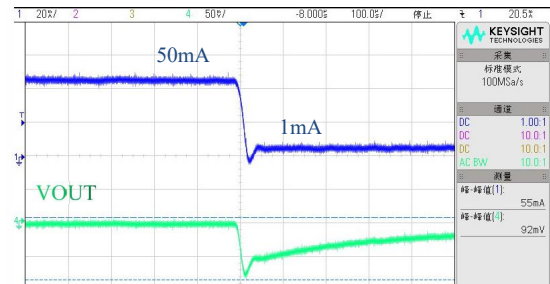
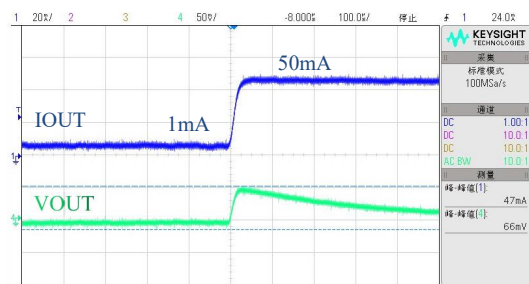

Application Information

In general, all the capacitors need to be low leakage. Any leakage the capacitors have will reduce efficiency, increase the quiescent current.

A recent trend in the design of portable devices has been to use ceramic capacitors to filter DC-DC converter inputs. Ceramic capacitors are often chosen because of their small size, low equivalent series resistance (ESR) and high RMS current capability. Also, recently, designers have been looking to ceramic capacitors due to shortages of tantalum capacitors.

Unfortunately, using ceramic capacitors for input filtering can cause problems. Applying a voltage step to a ceramic capacitor causes a large current surge that stores energy in the inductance of the power leads. A large voltage

spike is created when the stored energy is transferred from these inductance into the ceramic capacitor. These voltage spikes can easily be twice the amplitude of the input voltage step.

Many types of capacitors can be used for input bypassing, however, caution must be exercised when using multi layer ceramic capacitors (MLCC). Because of the self-resonant be generated under some start-up conditions, such as connecting the LDO input to a live power source.

The LDO also requires an output capacitor for loop stability. Connect a 1uF tantalum capacitor from OUT to GND close to the pins. For improved transient response, this output capacitor may be ceramic.

TX6214 series

Ultra Low Current Consumption 400mA CMOS Voltage Regulator

Marking Description

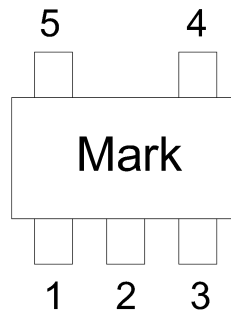

- ① product code: 4
② output voltage code:

Symbol	Voltage(V)	Symbol	Voltage(V)	Symbol	Voltage(V)	Symbol	Voltage(V)
a	0.9	A	3.5	n	2.2	N	4.8
b	1.0	B	3.6	o	2.3	O	4.9
c	1.1	C	3.7	P	2.4	P	5.0
d	1.2	D	3.8	q	2.5	Q	5.1
e	1.3	E	3.9	r	2.6	R	5.2
f	1.4	F	4.0	s	2.7	S	5.3
g	1.5	G	4.1	t	2.8	T	5.4
h	1.6	H	4.2	u	2.9	U	5.5
i	1.7	I	4.3	v	3.0	V	5.6
j	1.8	J	4.4	w	3.1	W	5.7
k	1.9	K	4.5	x	3.2	X	5.8
l	2.0	L	4.6	y	3.3	Y	5.9
m	2.1	M	4.7	z	3.4	Z	6.0

③④: The last two of them are based on the time of this product which is the first time into production, the third is the year of this product first time into production, such as expressed in "1" in 2021, in "2" in 2022 and the fourth is the month of this product first time into production, it can be in 1 ~ 9, which is expressed in "0" in October, in November with an "A", in December with "B"; . For example: 4y16 represents TX6214-33M5R product is first put into production in June in 2021.

TX6214 series

Ultra Low Current Consumption 400mA CMOS Voltage Regulator

Package Information

3-pin SOT23-3 Outline Dimensions

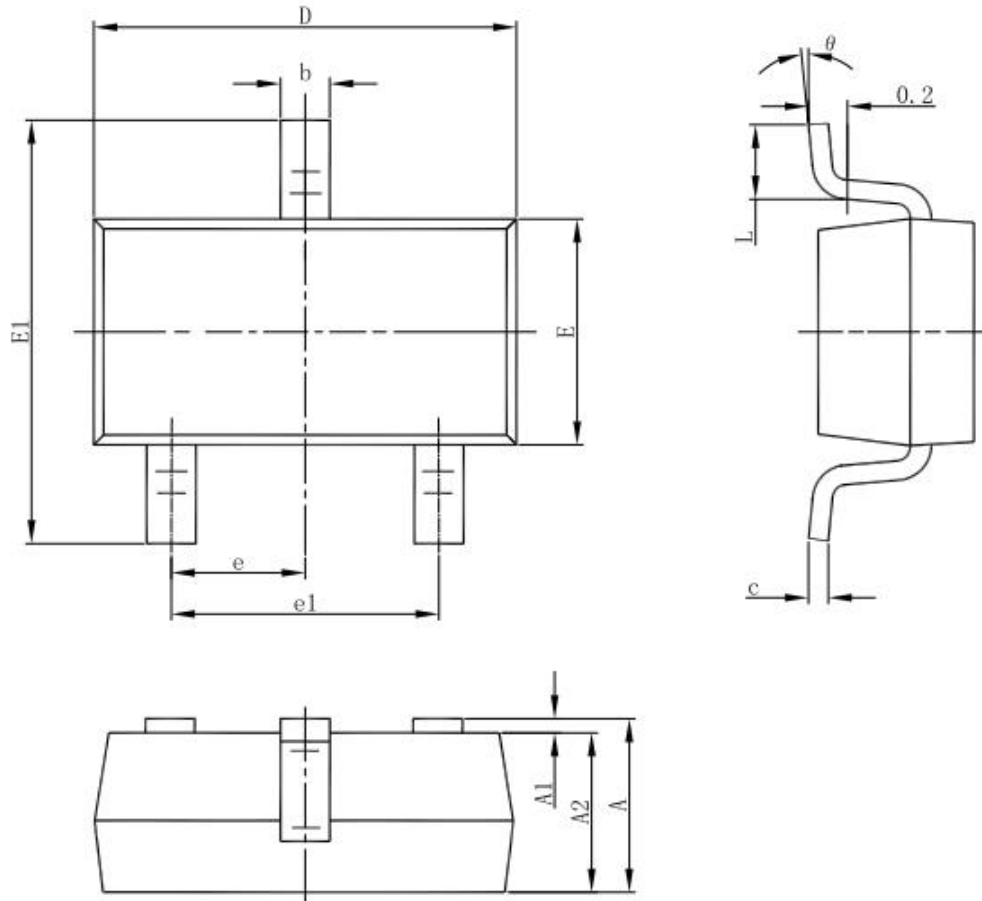

Symbol	Dimensions In Millimeters		Dimensions In Inches	
	Min	Max	Min	Max
A	1.050	1.250	0.041	0.049
A1	0.000	0.100	0.000	0.004
A2	1.050	1.150	0.041	0.045
b	0.300	0.500	0.012	0.020
c	0.100	0.200	0.004	0.008
D	2.820	3.020	0.111	0.119
E	1.500	1.700	0.059	0.067
E1	2.650	2.950	0.104	0.116
e	0.950(BSC)		0.037(BSC)	
e1	1.800	2.000	0.071	0.079
L	0.300	0.600	0.012	0.024
theta	0°	8°	0°	8°

TX6214 series

Ultra Low Current Consumption 400mA CMOS Voltage Regulator

SOT23-5 Outline Dimensions

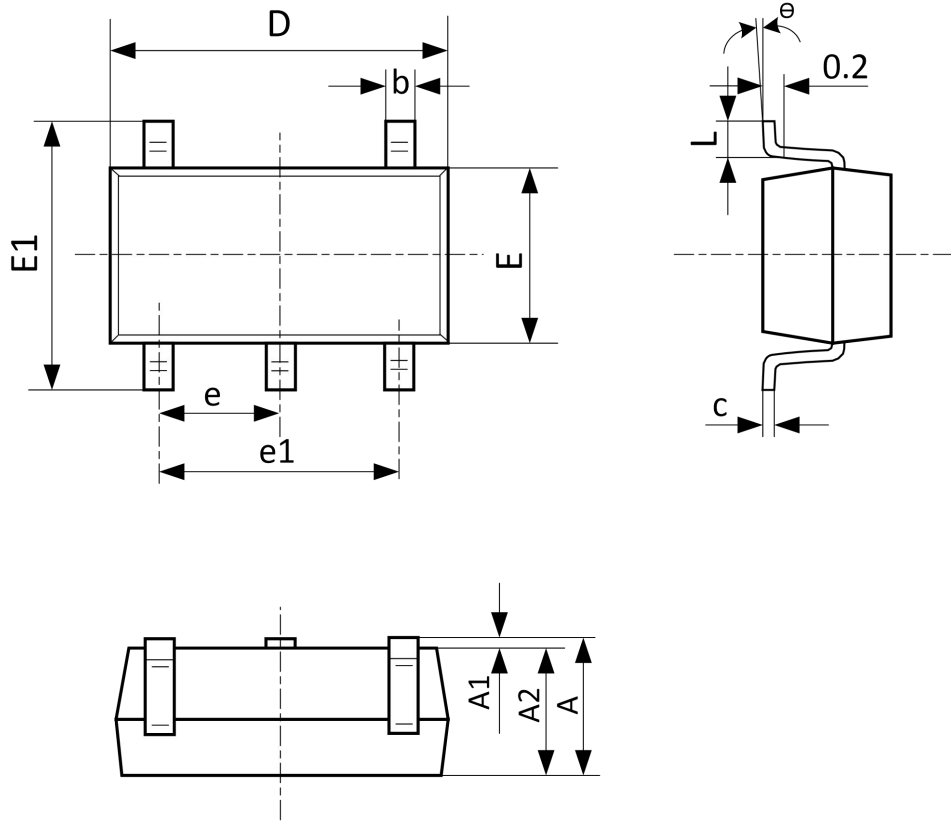

Symbol	Dimensions In Millimeters		Dimensions In Inches	
	Min	Max	Min	Max
A	1.050	1.250	0.041	0.049
A1	0.000	0.100	0.000	0.004
A2	1.050	1.150	0.041	0.045
b	0.300	0.500	0.012	0.020
c	0.100	0.200	0.004	0.008
D	2.820	3.020	0.111	0.119
E	1.500	1.700	0.059	0.067
E1	2.650	2.950	0.104	0.116
e	0.950(BSC)		0.037(BSC)	
e1	1.800	2.000	0.071	0.079
L	0.300	0.600	0.012	0.024
θ	0°C	8°C	0°C	8°C

DFN1*1-4 Outline Dimensions

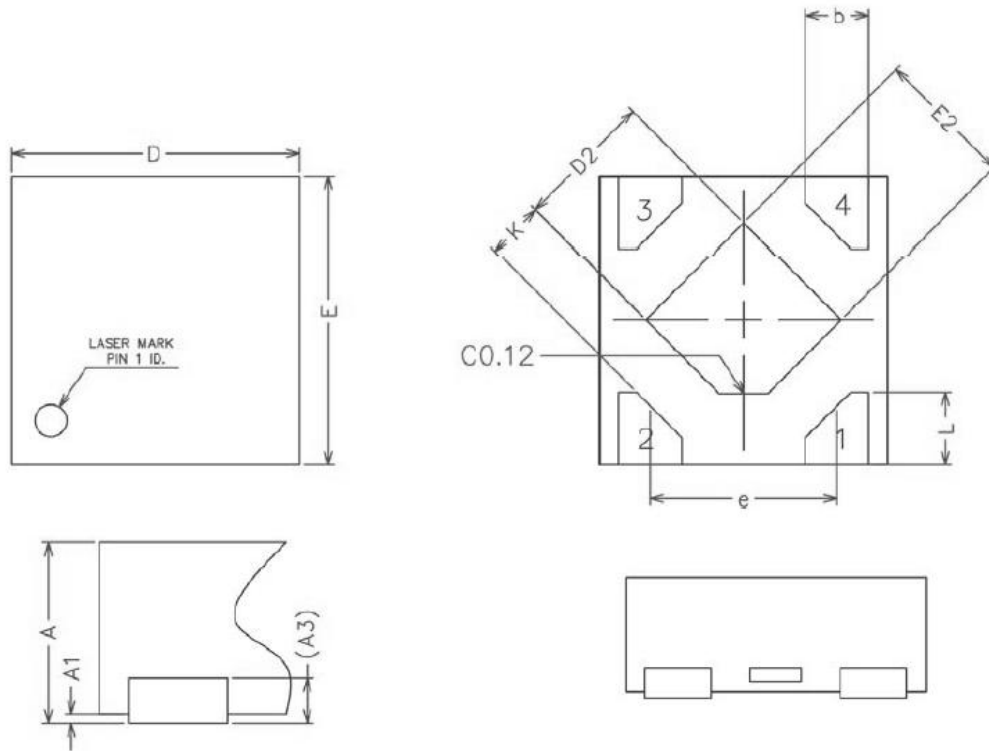

COMMON DIMENSIONS
(UNITS OF MEASURE=MILLIMETER)

SYMBOL	MIN	NOM	MAX
A	0.34	0.37	0.40
A1	0.00	0.02	0.05
A3	0.100REF		
b	0.17	0.22	0.27
D	0.95	1.00	1.05
E	0.95	1.00	1.05
D2	0.43	0.48	0.53
E2	0.43	0.48	0.53
L	0.20	0.25	0.30
e	—	0.65	—
K	0.15	—	—